

GALFRE

COSTRUZIONI MACCHINE AGRICOLE

di GALFRE' DOMENICO & C. s.n.c.
Via Centallo, 136 - ROATA CHIUSANI
12044 CENTALLO (CN) - ITALY
Tel. 0171.718005 - Fax 0171.718004
Sito internet: www.galfre.net
E-mail: info@galfre.net - 06

CATALOGO RICAMBI

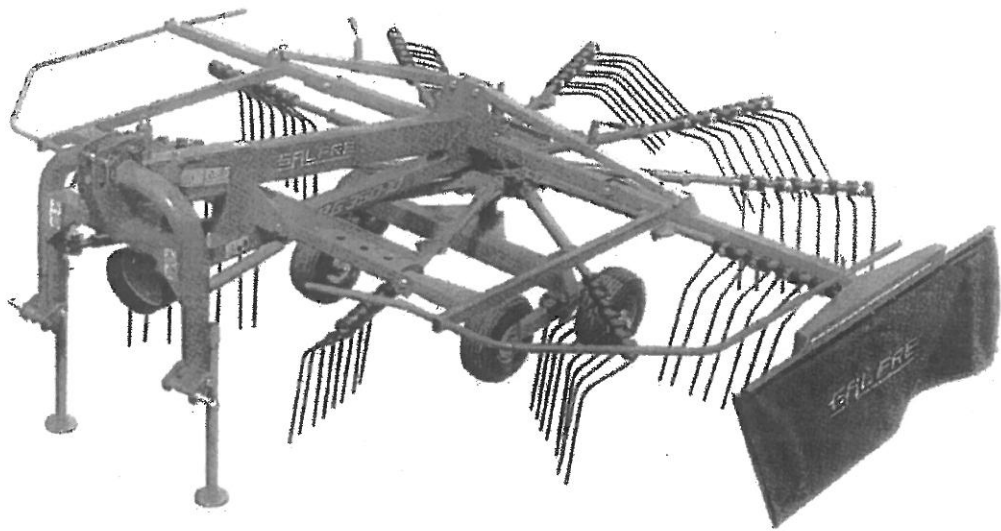

ANDANATORI CIRCOLARI AG

- AG350/10

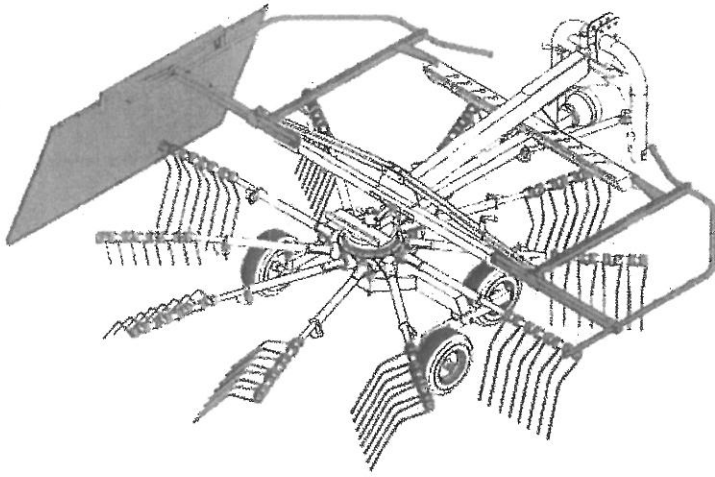

Gruppo Protezioni

tav.1

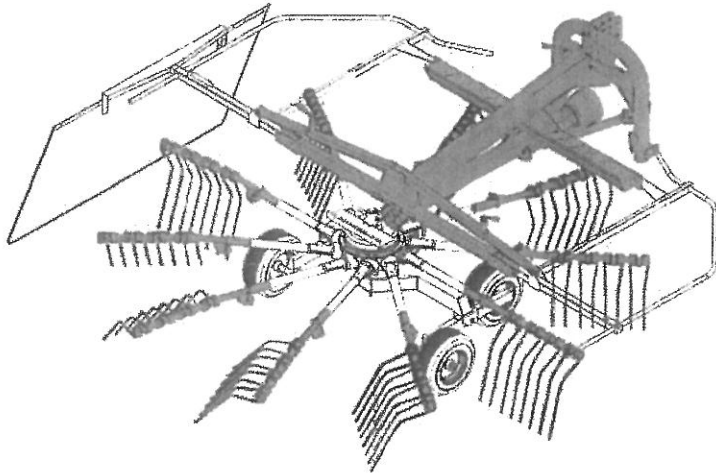

Gruppo Tiro

tav.2

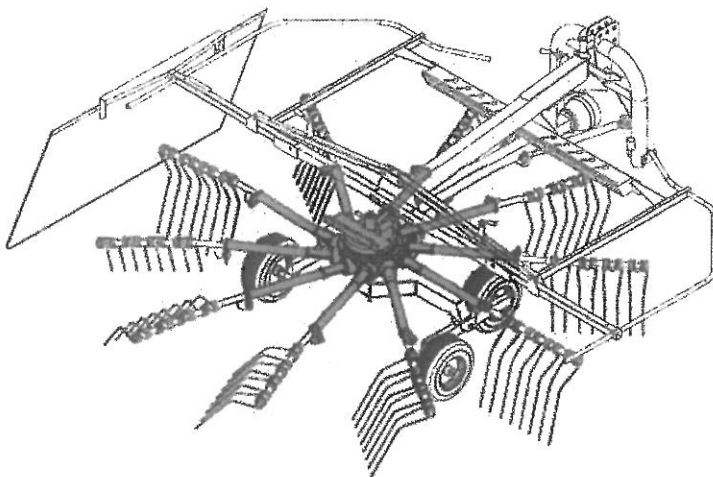

Gruppo Girante

tav.3

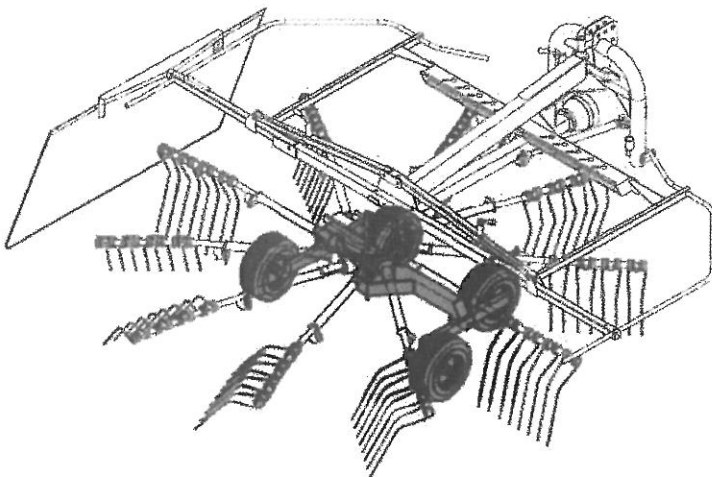

Gruppo Assale

tav.4

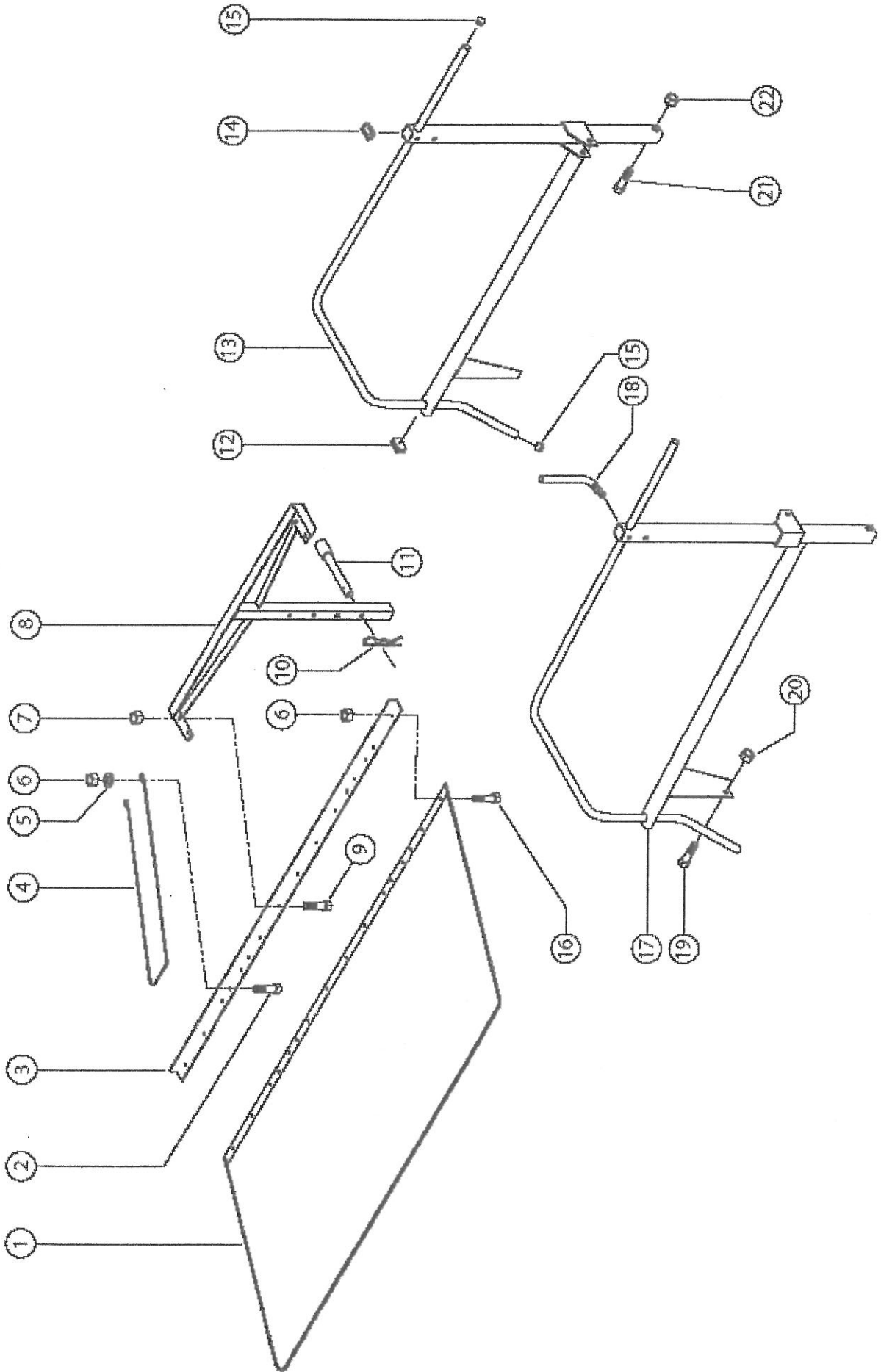

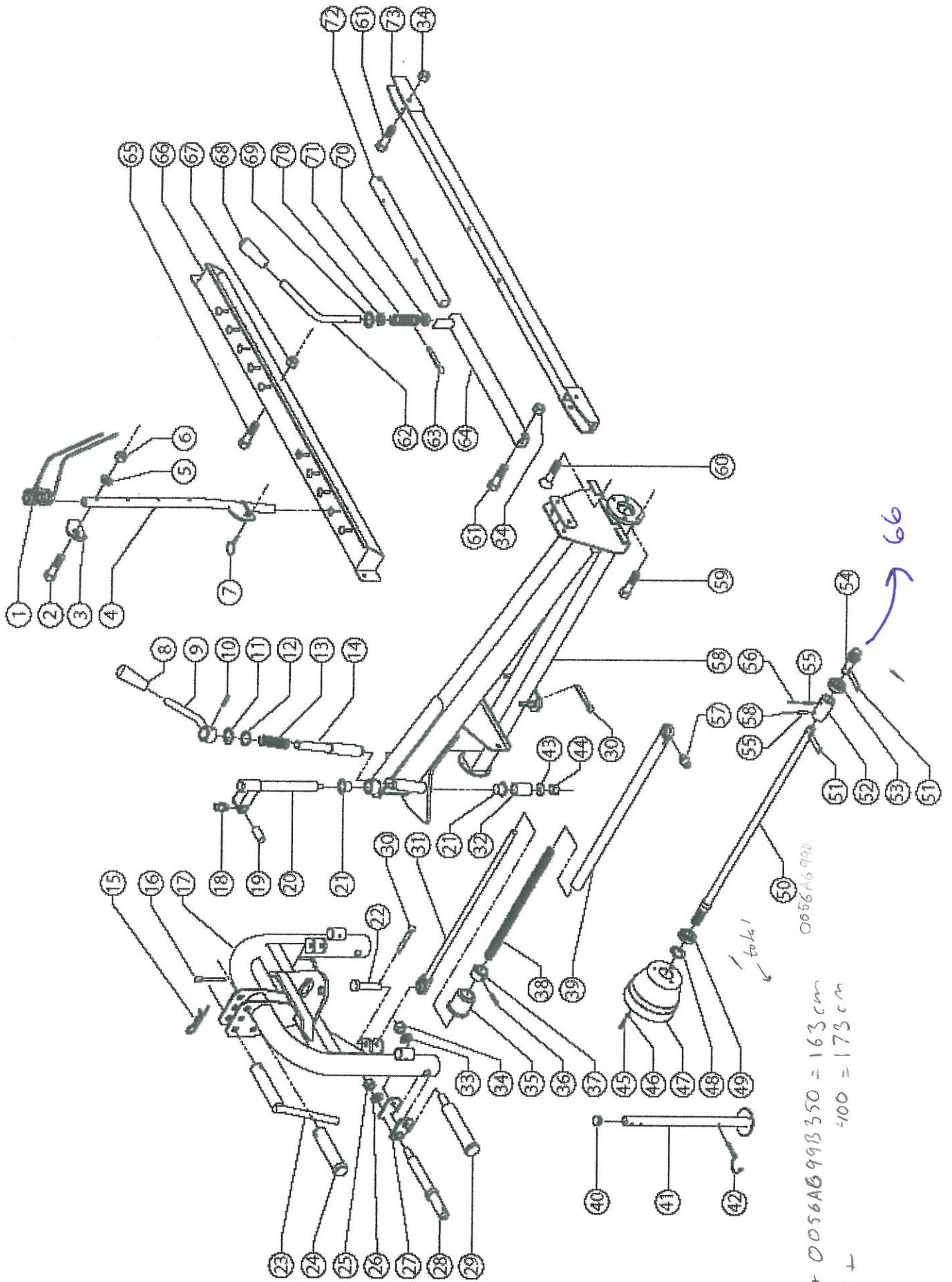

total 54+ 0056A699B350 = 163 cm
total 54+ 400 = 173 cm

total

0056A699B

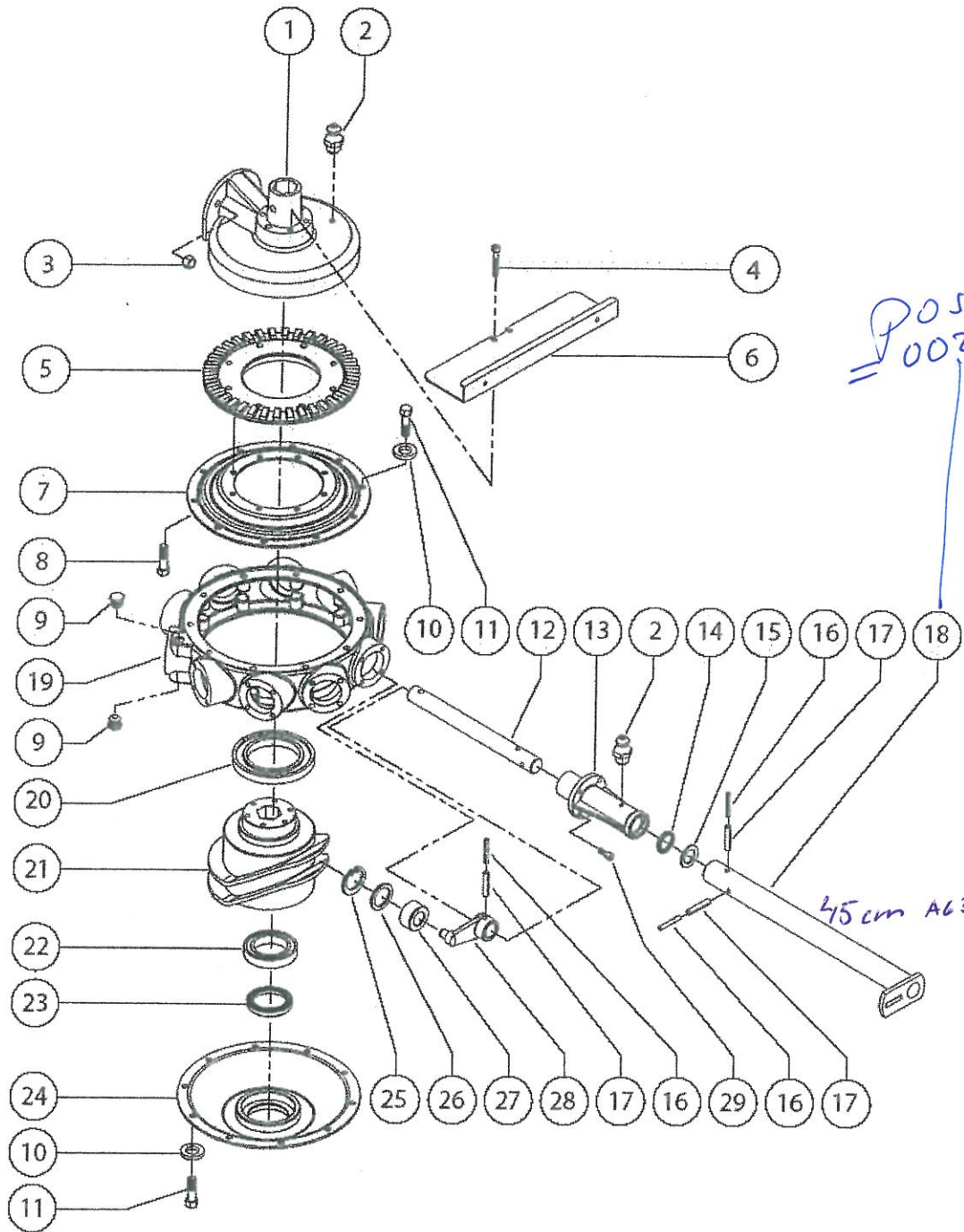

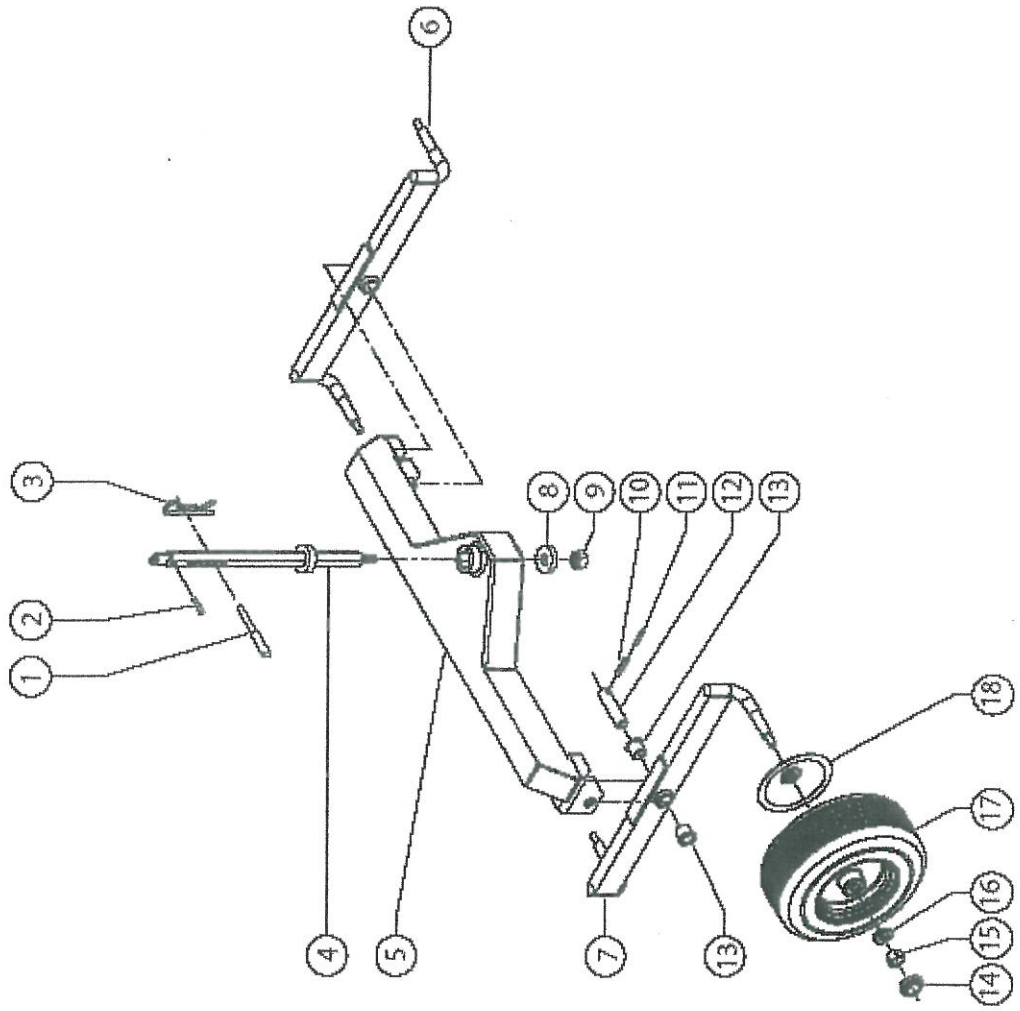

15x6,00-6